

FITTING INSTRUCTION

Clamp mark in acc. with		Cables joining
ISO	PN	
1	L	Left directional lights
2	+	Rear fog lights
3	31	Ground
4	R	Right directional lights
5	58R	Right side parking lights
6	54	Stoplights
7	58L	Left side parking lights

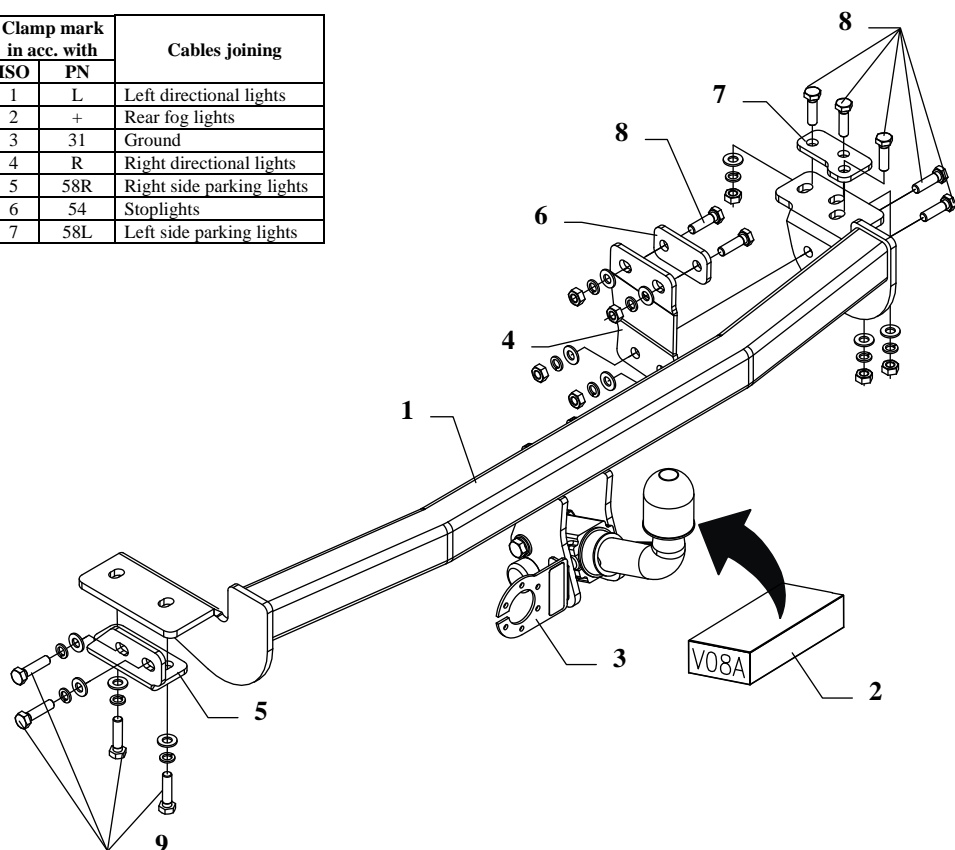

Fig. 1

This towbar is designed to assembly in following car: **NISSAN ALMERA 4 doors, N15**, produced since 09.1995 till 03.2000, catalogue no. **V08A** and is prepared to tow trailers max total weight **1600 kg** and max vertical load **75 kg**.

From manufacturer

Thank you for buying our product. Their reliability has been confirmed in many tests. Reliability of towbar depends also on correct assembly and right exploit. For this reasons we kindly ask to read carefully this instruction and apply to hints.

The towbar should be install in points described by a car producer.

The instruction of the assembly

1. Unscrew the bumper.
2. Get lower a muffler and unscrew thermal shield.
3. Unscrew original tow eye (not used any more).
4. Cut out fragment of bumper as shown in the fig. 2.

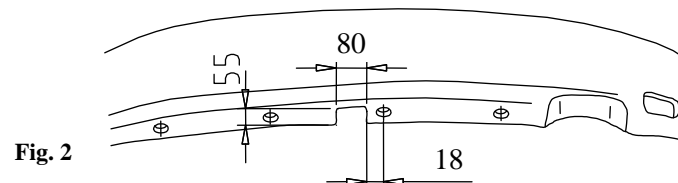

Fig. 2

5. From rear part of car body remove bumper handle (on the right side) – see fig. 3.

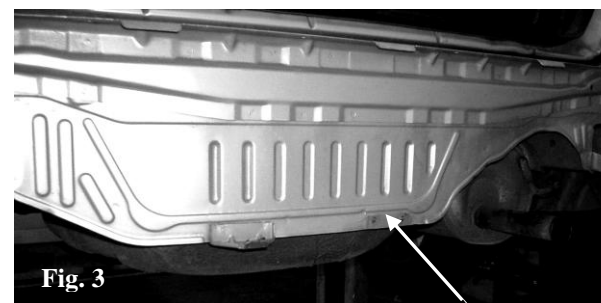

Fig. 3

Remove handle

6. Put main bar of the towbar (pos. 1) to chassis and fix as shown in the fig. 1, use angle element – pos. 5 (left side) and elements pos. 4, 6 and 7 (right side).
7. Assemble the bumper.
8. Fix body of the automat and place tow-ball according to supplied instruction. Note! Remember to place socket plate (pos. 3) as shown on the drawing 1.
9. Tighten all bolts according to the torque shown in the table.
10. Connect electric wires of 7-poles socket according to the instruction of the car. (Recommend to make at authorized service station).
11. Complete the paint coating damaged during installation.

Torque settings for nuts and bolts (8,8):	
M 8 - 25 Nm	M 10 - 55 Nm
M 12 - 85 Nm	M 14 - 135 Nm







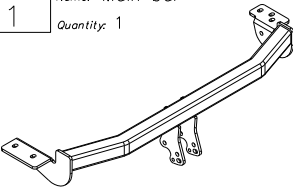
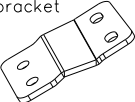

NOTE

After install the towbar you should get adequate note in registration book (at authorised service station).The car should be equipped with:

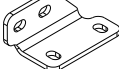
- Indicators
- Tow mirrors

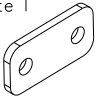
After 1000km of exploitation check all bolts and nuts. The ball of towbar must be always kept clear and conserve with a grease.

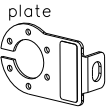
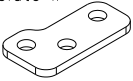
Towbar accessories:

Pos. 1	Name: Main bar Quantity: 1	Pos. 4	Name: Right bracket Quantity: 1	Pos. 8	Name: Bolt 8,8 B Quantity: 7 Dim.: M10x35mm
					
		Pos. 5	Name: Left bracket Quantity: 1	Pos. 9	Name: Bolt 8,8 B Quantity: 4 Dim.: M10x1,25x40
					
Pos. 2	Name: Tow ball Quantity: 1	Pos. 6	Name: Fish-plate I Quantity: 1	Pos. 10	Name: Nut 8 B Quantity: 7 Dim.: M10
					
Pos. 3	Name: Socket plate Quantity: 1	Pos. 7	Name: Fish-plate II Quantity: 1	Pos. 11	Name: Plain washer Quantity: 11 Dim.: Ø 10,5 mm
					
				Pos. 12	Name: Spring washer Quantity: 11 Dim.: Ø 10,2 mm
					



PPUH AUTO-HAK S.J.

Produkcja Zaczepów Kulowych
Henryk i Zbigniew Nejman
76-200 SŁUPSK ul. Słoneczna 16K
tel/fax (059) 8-414-414; 8-414-413
E-mail: office@autohak.com.pl
www.autohak.com.pl

Towing hitch (without electrical set)

Class: **A50-X** Cat. no. **V08A**

Designed for:

Manufacturer: **NISSAN**

Model: **ALMERA**

Type: **4 doors (N15)**

produced since 09.1995 till 03.2000

Technical data:

D-value: 8,0 kN

maximum trailer weight: **1600 kg**

maximum vertical cup load: **75 kg**

Approval number according to Directive 94/20/EC: e20*94/20*1041*00

Foreword

This towbar is designed according to rules of safety traffic regulations. The towing hitch is a safety component and can be install only by qualified personnel. Any alteration or conversion of the towing hitch is prohibited and would lead to cancellation of design certification. Remove insulating compound and underseal from vehicle (if present) in the area of the matting surfaces of the towing hitch.

The vehicle manufacturer's specifications regarding trailer load and max. vertical cup load are decisive for driving, and values for the towing hitch cannot be exceeded.

D-value formula:

$$\frac{\text{Max trailer weight [kg]} \times \text{Max vehicle weight [kg]}}{\text{Max trailer weight [kg]} + \text{Max vehicle weight [kg]}} \times \frac{9,81}{1000} = D \text{ [kN]}$$