

## FITTING INSTRUCTION

Clamp mark in acc. with		Cables joining
ISO	PN	
1	L	Left directional lights
2	+	Rear fog lights
3	31	Ground
4	R	Right directional lights
5	58R	Right side parking lights
6	54	Stoplights
7	58L	Left side parking lights

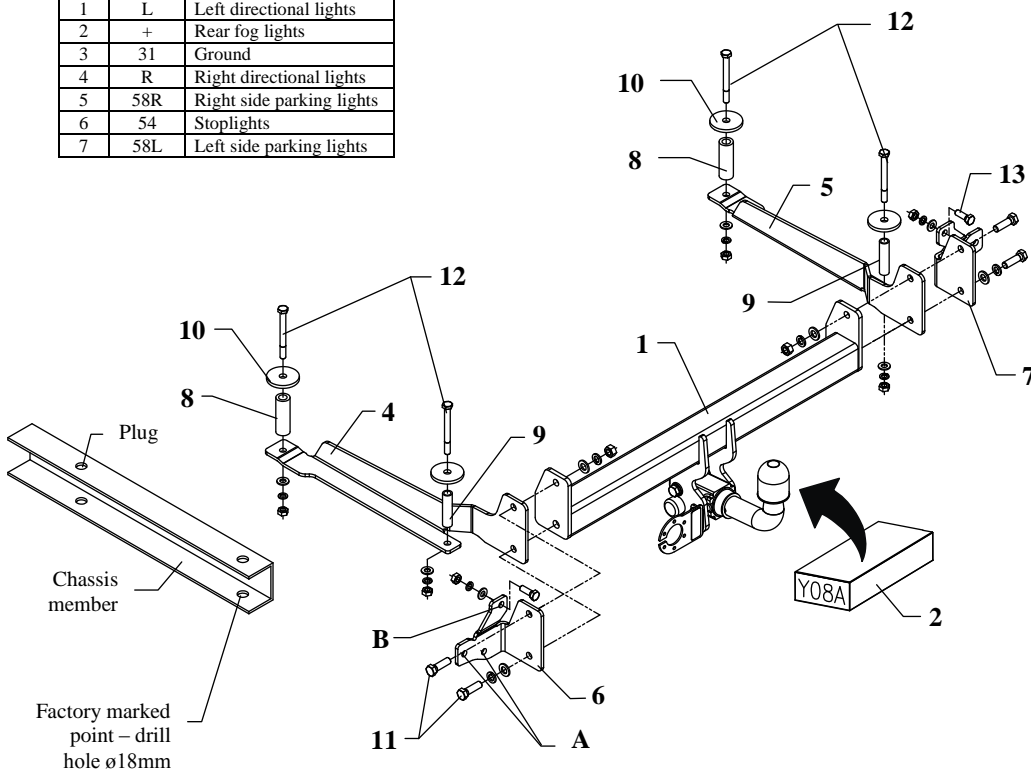

This towbar is designed to assembly in following cars:  
**HONDA ACCORD 4/5 doors, (CG, CH), except Coupe**, produced since 11.1998 till 10.2002, catalogue no. **Y08A** and is prepared to tow trailers max total weight **1500 kg** and max vertical load **60 kg**.

### *From manufacturer*

Thank you for buying our product. Their reliability has been confirmed in many tests. Reliability of towbar depends also on correct assembly and right operation. For this reasons we kindly ask to read carefully this instruction and apply to hints.

*The towbar should be installing in points described by a car producer.*

## The instruction of the assembly

1. Disassemble a bumper and muffler and in trunk remove side and rear covers.
2. Disassemble metal bowl from bumper (not used any more).
3. In factory marked points (under conserve layer) on left and right side of trunk make holes using bit  $\varnothing 18\text{mm}$ .
4. To made holes slip sleeves  $\varnothing 17\text{mm}$  length=68mm (pos. 9).
5. Ad distance 403mm of made holes remove rubber plugs and slip to this places distance sleeves  $\varnothing 25\text{mm}$  length=74mm (pos. 8).
6. From below the car, to chassis members put brackets (pos. 4 and 5) and fix loosely through sleeves.
7. On outstanding pins M8 (in rear part of car) put side brackets (pos. 6 and 7) and through holes (pos. A) fix loosely using nuts remaining for metal bowl removal.
8. Between installed parts of towbar put the main bar of the towbar (pos. 1) and fix using bolts M12x40mm (pos. 11).
9. Through holes (pos. B) drill holes  $\varnothing 11\text{mm}$  in rear part and screw using bolts M10x30mm (pos. 13).
10. Tighten all bolts according to the torque shown in the table.
11. Fix body of the automat and place tow-ball according to supplied instruction. Note! Remember to place socket plate (pos. 3) as shown on the drawing 1.
12. Reinstall muffler and covers in a trunk.
13. Reinstall bumper after cut out his fragment 75x55mm in lower part.
14. Connect electric wires of 7-poles socket according to the instruction of the car. (Recommend to make at authorized service station).
15. Complete the paint coating damaged during installation.

Torque settings for nuts and bolts (8,8):	
<b>M 8</b> - 25 Nm	<b>M 10</b> - 55 Nm
<b>M 12</b> - 85 Nm	<b>M 14</b> - 135 Nm











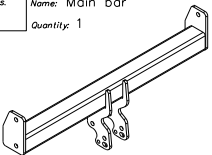

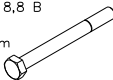



### NOTE

After install the towbar you should get adequate note in registration book (at authorised service station).The car should be equipped with:

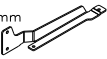
- Indicators
- Tow mirrors

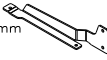
Check all bolts and nuts after 1000km of exploitation. The ball of towbar must be always kept clear and conserve with a grease.

## Towbar accessories:

Pos. 1 Name: Main bar Quantity: 1 	Pos. 6 Name: Left side bracket Quantity: 1 Dim.: 128x118x101mm 	Pos. 12 Name: Bolt 8,8 B Quantity: 4 Dim.: M10x100mm 	Pos. 18 Name: Spring washer Quantity: 4 Dim.: Ø 12,2 mm 
Pos. 2 Name: Tow ball Quantity: 1 	Pos. 7 Name: Right side bracket Quantity: 1 Dim.: 128x118x101mm 	Pos. 13 Name: Bolt 8,8 B Quantity: 2 Dim.: M10x30mm 	Pos. 19 Name: Spring washer Quantity: 6 Dim.: Ø 10,2 mm 
Pos. 3 Name: Socket plate Quantity: 1 	Pos. 8 Name: Distance sleeve Quantity: 2 Dim.: Ø25x5; L=74mm 	Pos. 14 Name: Nut 8 B Quantity: 2 Dim.: M12 	
Pos. 4 Name: Right bracket Quantity: 1 Dim.: 582x128x85mm 	Pos. 9 Name: Distance sleeve Quantity: 2 Dim.: Ø17,2x2,35; L=68mm 	Pos. 15 Name: Nut 8 B Quantity: 6 Dim.: M10 	
Pos. 5 Name: Left bracket Quantity: 1 Dim.: 582x128x85mm 	Pos. 10 Name: Washer Quantity: 4 Dim.: Ø58xØ12x6mm 	Pos. 16 Name: Plain washer Quantity: 4 Dim.: Ø 13 mm 	
	Pos. 11 Name: Bolt 8,8 B Quantity: 4 Dim.: M12x40mm 	Pos. 17 Name: Plain washer Quantity: 6 Dim.: Ø 10,5 mm 	



**PPUH AUTO-HAK S.J.**

Produkcja Zaczepów Kulowych  
Henryk i Zbigniew Nejman  
76-200 SŁUPSK ul. Słoneczna 16K  
tel/fax (059) 8-414-414; 8-414-413  
e-mail: [office@autohak.com.pl](mailto:office@autohak.com.pl)  
[www.autohak.com.pl](http://www.autohak.com.pl)

## Towing hitch (without electrical set)

Class: **A50-X** Cat. no. **Y08A**

Designed for:

Manufacturer: **HONDA**

Model: **ACCORD**

Type: **4/5 doors, (CG, CH), except Coupe**

produced since 11.1998 till 10.2002

Technical data:

**D-value: 8,31 kN**

maximum trailer weight: **1500 kg**

maximum vertical cup load: **60 kg**

**Approval number according to Directive 94/20/EC: e20\*94/20\*0977\*00**

## Foreword

This towbar is designed according to rules of safety traffic regulations. The towing hitch is a safety component and can be install only by qualified personnel. Any alteration or conversion of the towing hitch is prohibited and would lead to cancellation of design certification. Remove insulating compound and underseal from vehicle (if present) in the area of the matting surfaces of the towing hitch.

The vehicle manufacturer's specifications regarding trailer load and max. vertical cup load are decisive for driving, and values for the towing hitch cannot be exceeded.

*D-value formula:*

$$\frac{\text{Max trailer weight [kg]} \times \text{Max vehicle weight [kg]}}{\text{Max trailer weight [kg]} + \text{Max vehicle weight [kg]}} \times \frac{9,81}{1000} = D \text{ [kN]}$$