

FITTING INSTRUCTION

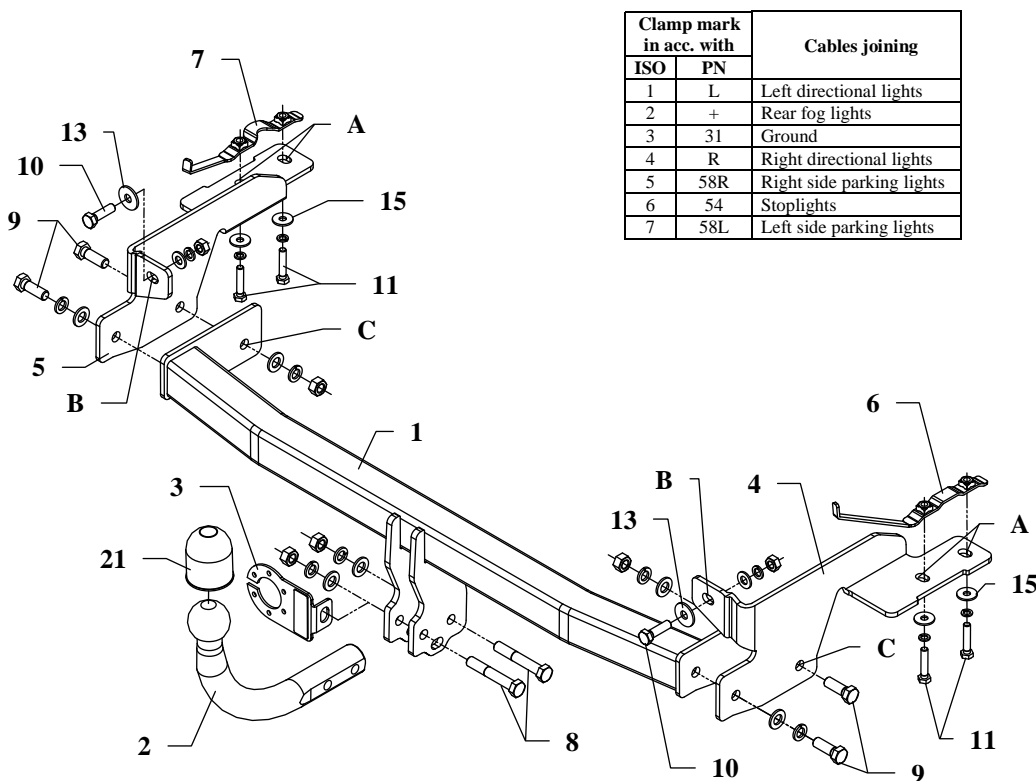

Clamp mark in acc. with		Cables joining
ISO	PN	
1	L	Left directional lights
2	+	Rear fog lights
3	31	Ground
4	R	Right directional lights
5	58R	Right side parking lights
6	54	Stoptlights
7	58L	Left side parking lights

This towbar is designed to assembly in following cars:
FIAT PUNTO II, 3/5 door, except Sport, produced since 09.1999 till 2011, catalogue no. **R25** and is prepared to tow trailers max total weight **1200 kg** and max vertical load **60 kg**.

From manufacturer

Thank you for buying our product. Their reliability has been confirmed in many tests. Reliability of towbar depends also on correct assembly and right operation. For this reasons we kindly ask to read carefully this instruction and apply to hints.

The towbar should be install in points described by a car producer.

The instruction of the assembly

1. Disassemble the rear bumper.
2. Lower the silencer and unscrew the thermal sheet.
3. Take plastic covers out the bottom part of chassis members.
4. Under the conservation layer in the luggage part (please look for it in the nearest part of rear car's side), find elongated holes at the left and right side. Slide nuts on the jibs (pos. 6 and 7) there.
5. Apply left bracket (pos. 5) to the left chassis member, and right bracket (pos. 4) to the right one, then fit these elements to slided earlier nuts (pos. 6 and 7) through holes A, and next fit them to the rear panel through holes B.
6. Drill holes of supports C (use bit $\varnothing 12,5\text{mm}$).
7. Fix the main bar of the towbar (pos. 1) to brackets (pos. 4 and 5) with bolts M12x35mm (pos. 9).
8. Position the ball of towbar (pos. 2) with socket plate (pos. 3) and fix using bolts M12x75mm (pos. 8) from the towbar accessories.
9. Replace the silencer, the thermal sheet and the bumper.
10. Tighten all bolts according to the torque shown in the table.
11. Connect electric wires of 7-poles socket according to the instruction of the car. (Recommend to make at authorized service station).
12. Complete paint layer damaged during installation.

Torque settings for nuts and bolts (8,8):

M6 - 11 Nm	M8 - 25 Nm	M10 - 50 Nm
M12 - 87 Nm	M14 - 138 Nm	M16 - 210 Nm

NOTE

After install the towbar you should get adequate note in registration book (at authorised service station). The car should be equipped with:

- Indicators
- Tow mirrors

After 1000km of exploitation check all bolts and nuts. The ball of towbar must be always kept clear and conserve with a grease.

Towbar accessories:

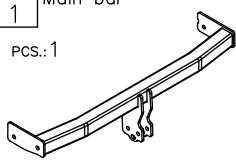
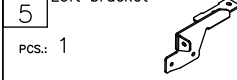
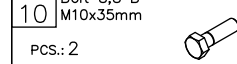
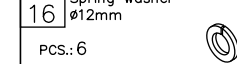
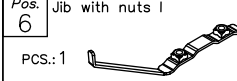
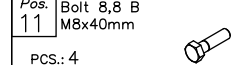
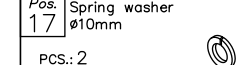
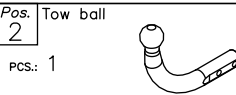
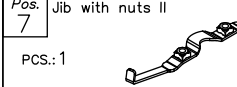
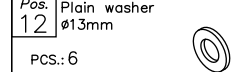
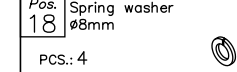
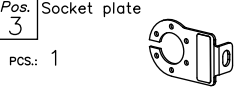
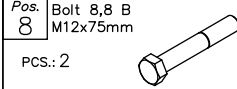
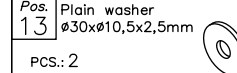
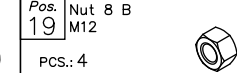
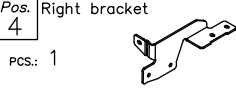
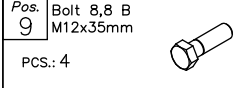
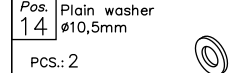
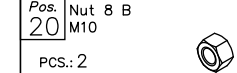
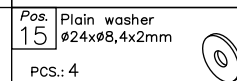
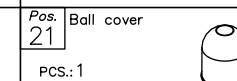
Pos. 1 Main bar  PCS.: 1	Pos. 5 Left bracket  PCS.: 1	Pos. 10 Bolt 8,8 B M10x35mm  PCS.: 2	Pos. 16 Spring washer ø12mm  PCS.: 6
	Pos. 6 Jib with nuts I  PCS.: 1	Pos. 11 Bolt 8,8 B M8x40mm  PCS.: 4	Pos. 17 Spring washer ø10mm  PCS.: 2
Pos. 2 Tow ball  PCS.: 1	Pos. 7 Jib with nuts II  PCS.: 1	Pos. 12 Plain washer ø13mm  PCS.: 6	Pos. 18 Spring washer ø8mm  PCS.: 4
Pos. 3 Socket plate  PCS.: 1	Pos. 8 Bolt 8,8 B M12x75mm  PCS.: 2	Pos. 13 Plain washer ø30xø10,5x2,5mm  PCS.: 2	Pos. 19 Nut 8 B M12  PCS.: 4
Pos. 4 Right bracket  PCS.: 1	Pos. 9 Bolt 8,8 B M12x35mm  PCS.: 4	Pos. 14 Plain washer ø10,5mm  PCS.: 2	Pos. 20 Nut 8 B M10  PCS.: 2
		Pos. 15 Plain washer ø24xø8,4x2mm  PCS.: 4	Pos. 21 Ball cover  PCS.: 1



PPUH AUTO-HAK Sp.J.

Produkcja Zaczepów Kulowych
 Henryk & Zbigniew Nejman
 76-200 SŁUPSK ul. Słoneczna 16K
 tel/fax (059) 8-414-414; 8-414-413
 E-mail: office@autohak.com.pl
www.autohak.com.pl

Towing hitch (without electrical set)

Class: **A50-X** Cat. no. **R25**

Designed for:

Manufacturer: **FIAT**

Model: **PUNTO II (188)**

Type: **3/5 door, except Sport**

produced since 09.1999 till 2011

Technical data:

D-value: 6,65 kN

maximum trailer weight: **1200 kg**

maximum vertical cup load: **60 kg**

Approval number acc. to regulations EKG/ONZ 55.01: E20-55R-01 0839

Foreword

This towbar is designed according to rules of safety traffic regulations. The towing hitch is a safety component and can be install only by qualified personnel. Any alteration or conversion of the towing hitch is prohibited and would lead to cancellation of design certification. Remove insulating compound and underseal from vehicle (if present) in the area of the matting surfaces of the towing hitch.

The vehicle manufacturer's specifications regarding trailer load and max. vertical cup load are decisive for driving whereat values for the towing hitch cannot be exceeded.

D-value formula:

$$\frac{\text{Max trailer weight [kg]} \times \text{Max vehicle weight [kg]}}{\text{Max trailer weight [kg]} + \text{Max vehicle weight [kg]}} \times \frac{9,81}{1000} = D \text{ [kN]}$$