

## FITTING INSTRUCTION

Clamp mark in acc. with		Cables joining
ISO	PN	
1	L	Left directional lights
2	+	Rear fog lights
3	31	Ground
4	R	Right directional lights
5	58R	Right side parking lights
6	54	Stoptlights
7	58L	Left side parking lights

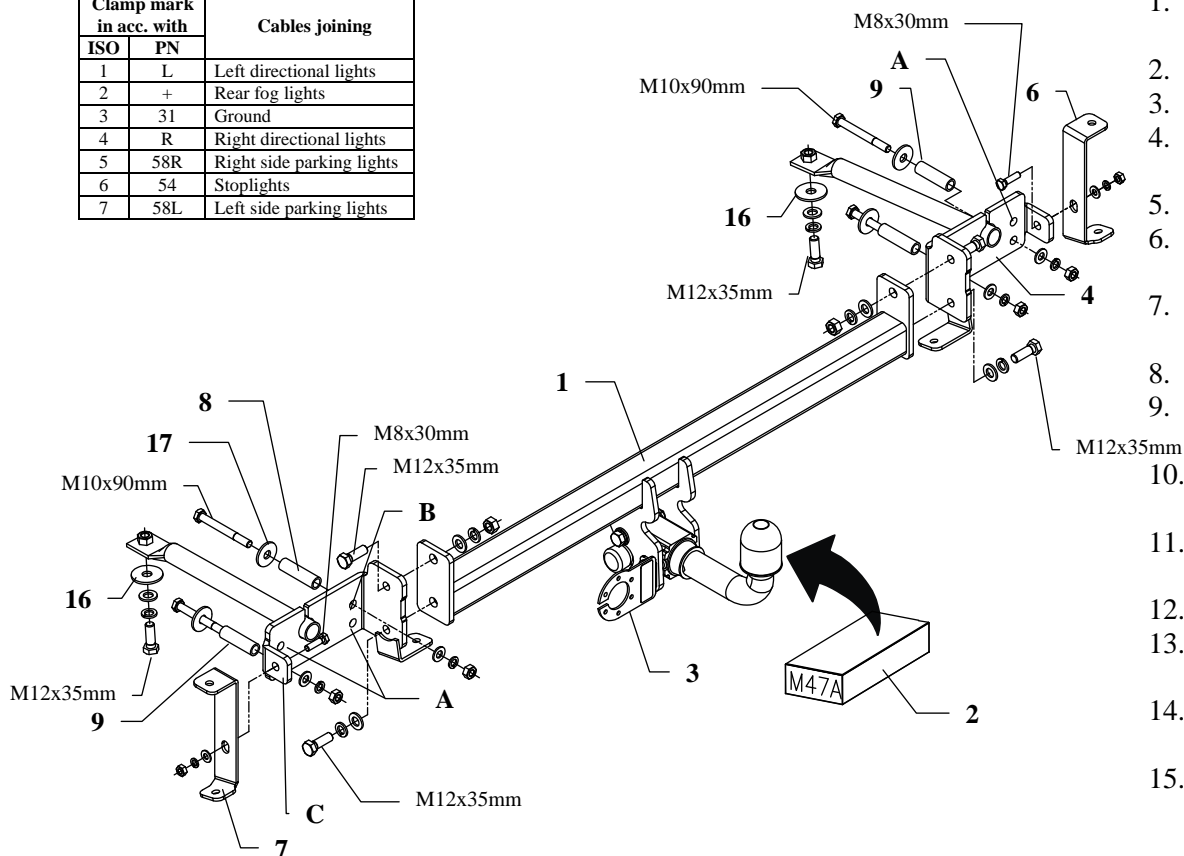

This towbar is designed to assembly in following cars:  
**MAZDA 626 Station Wagon, Estate (GV)**, produced since 09.1987 till 11.1996, catalogue number **M47A** and is prepared to tow trailers max total weight **1300 kg** and max vertical load **75 kg**.

### *From manufacturer*

Thank you for buying our product. Their reliability has been confirmed in many tests. Reliability of towbar depends also on correct assembly and right operation. For this reasons we kindly ask to read carefully this instruction and apply to hints.

*The towbar should be install in points described by a car producer.*

## The instruction of the assembly

1. Disassemble the rear bumper, next unscrew metal handles (not used any more).
2. From rear part of the body remove rubber dummies.
3. Drill holes  $\varnothing 50\text{mm}$  in rear wall of chassis members to make it open.
4. To drilled holes put side brackets (pos. 4 and 5) and fix it through holes A using bolts and nuts remained after bumper disassembly.
5. Through holes B and C drill straight using bit  $\varnothing 11\text{mm}$ .
6. Hole B enlarge only from inside using bit  $\varnothing 17\text{mm}$ . Next put distance sleeves  $\varnothing 17\text{mm}$ ,  $L=62\text{mm}$  (pos. 8).
7. Disassemble brackets 4 and 5, put distance sleeves  $\varnothing 17\text{mm}$ ,  $L=58\text{mm}$  (pos. 8) in hole C.
8. Reassemble brackets 4 and 5 again. Fix as shown in the figure.
9. Between installed side brackets put main bar of the towbar (pos. 1) and fix all using bolts M12x35mm (pos. 10).
10. To the bumper fix side handles (pos. 6 and 7) using bolts remained after original handles disassembly.
11. Bumper with handles put to the car and join with the towbar as shown in the figure.
12. Fix tight all bolts according to the torque shown in the table.
13. Fix body of the automat and place tow-ball according to supplied instruction. Note! Remember to place socket plate (pos. 3) as shown on the drawing 1.
14. Connect electric wires of 7-poles socket according to the instruction of the car. (Recommend to make at authorized service station)
15. Complete paint layer damaged during installation.

Torque settings for nuts and bolts (8,8):	
<b>M 8</b> - 25 Nm	<b>M 10</b> - 55 Nm
<b>M 12</b> - 85 Nm	<b>M 14</b> - 135 Nm











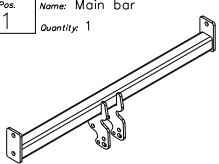











### NOTE

After install the towbar you should get adequate note in registration book (at authorised service station).The car should be equipped with:

- Indicators
- Tow mirrors

After 1000km check all bolts and nuts. The ball of towbar must be always kept clear and conserve with a grease.

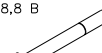
## Towbar equipment:

Pos. 1 Name: Main bar Quantity: 1 	Pos. 6 Name: Right handle Quantity: 1 	Pos. 12 Name: Bolt 8,8 B Quantity: 2 Dim.: M8x30mm 	Pos. 18 Name: Plain washer Quantity: 6 Dim.: Ø 13 mm 
	Pos. 7 Name: Left handle Quantity: 1 	Pos. 13 Name: Nut 8 B Quantity: 2 Dim.: M12 	Pos. 19 Name: Plain washer Quantity: 4 Dim.: Ø 10,5 mm 
Pos. 2 Name: Tow ball Quantity: 1 	Pos. 8 Name: Distance sleeve I Quantity: 2 Dim.: Ø17x2mm L=62mm 	Pos. 14 Name: Nut 8 B Quantity: 4 Dim.: M10 	Pos. 20 Name: Plain washer Quantity: 2 Dim.: Ø 8,5 mm 
Pos. 3 Name: Socket plate Quantity: 1 	Pos. 9 Name: Distance sleeve II Quantity: 2 Dim.: Ø17x2mm L=58mm 	Pos. 15 Name: Nut 8 B Quantity: 2 Dim.: M8 	Pos. 21 Name: Spring washer Quantity: 6 Dim.: Ø 12,2 mm 
Pos. 4 Name: Right bracket Quantity: 1 	Pos. 10 Name: Bolt 8,8 B Quantity: 6 Dim.: M12x35mm 	Pos. 16 Name: Special washer Quantity: 2 Dim.: Ø42xØ13x3mm 	Pos. 22 Name: Spring washer Quantity: 4 Dim.: Ø 10,2 mm 
Pos. 5 Name: Left bracket Quantity: 1 	Pos. 11 Name: Bolt 8,8 B Quantity: 4 Dim.: M10x90mm 	Pos. 17 Name: Special washer Quantity: 4 Dim.: Ø35xØ12x3mm 	Pos. 23 Name: Spring washer Quantity: 2 Dim.: Ø 8,2 mm 



**PPUH AUTO-HAK S.J.**

Produkcja Haków Holowniczych  
Henryk i Zbigniew Nejman  
76-200 SŁUPSK ul. Słoneczna 16K  
tel/fax (059) 8-414-414; 8-414-413  
E-mail: [office@autohak.com.pl](mailto:office@autohak.com.pl)  
[www.autohak.com.pl](http://www.autohak.com.pl)

## Towing hitch (without electrical set)

Class: **A50-X** Cat. no. **M47A**

Designed for:

Manufacturer: **MAZDA**

Model: **626 Station Wagon**

Type: **ESTATE (GV)**

produced since 09.1987 till 11.1996

Technical data:

**D-value: 8,7 kN**

maximum trailer weight: **1300 kg**

maximum vertical cup load: **75 kg**

Approval number according to Directive 94/20/EC: **e20\*94/20\*1170\*00**

## Foreword

This towbar is designed according to rules of safety traffic regulations. The towing hitch is a safety component and can be install only by qualified personnel. Any alteration or conversion of the towing hitch is prohibited and would lead to cancellation of design certification. Remove insulating compound and underseal from vehicle (if present) in the area of the matting surfaces of the towing hitch.

The vehicle manufacturer's specifications regarding trailer load and max. vertical cup load are decisive for driving whereat values for the towing hitch cannot be exceeded.

*D-value formula:*

$$\frac{\text{Max trailer weight [kg]} \times \text{Max vehicle weight [kg]}}{\text{Max trailer weight [kg]} + \text{Max vehicle weight [kg]}} \times \frac{9,81}{1000} = D \text{ [kN]}$$