

FITTING INSTRUCTION

Clamp mark in acc. with		Cables joining
ISO	PN	
1	L	Left directional lights
2	+	Rear fog lights
3	31	Ground
4	R	Right directional lights
5	58R	Right side parking lights
6	54	Stoptlights
7	58L	Left side parking lights

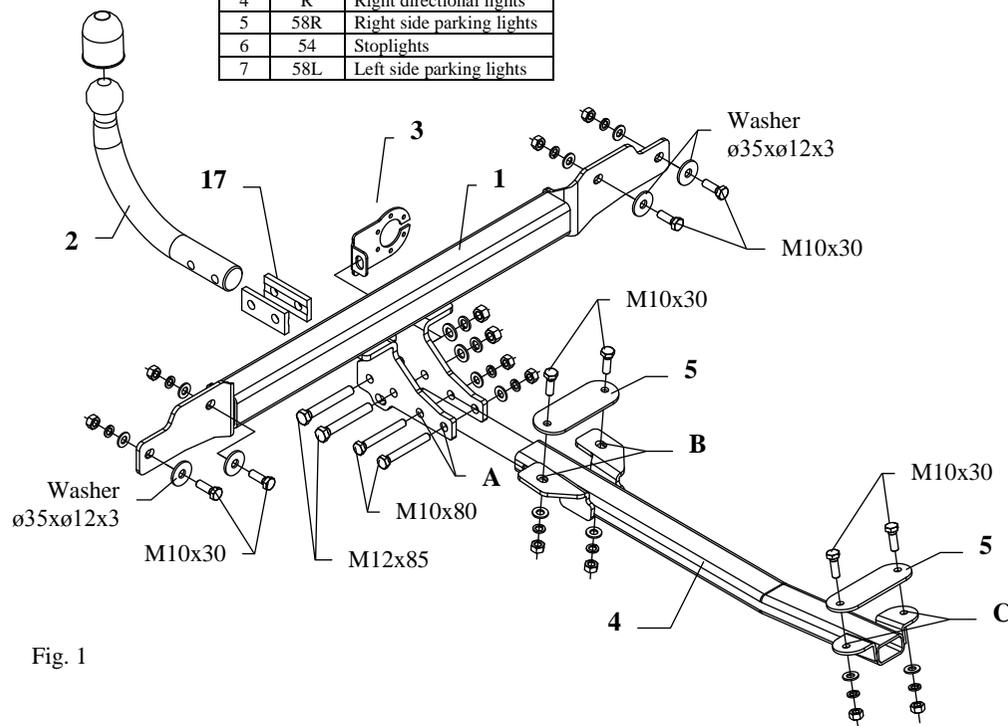

Fig. 1

This towbar is designed to assembly in following cars:
AUDI 80, 4 doors, except Quattro, (B3), produced since 09.1986 till 08.1991, catalogue no. **A16** and is prepared to tow trailers max total weight **1500 kg** and max vertical load **50 kg**.

From manufacturer

Thank you for buying our product. Their reliability has been confirmed in many tests. Reliability of towbar depends also on correct assembly and right operation. For this reasons we kindly ask to read carefully this instruction and apply to hints.

The towbar should be install in points described by a car producer.

The instruction of the assembly

- For the purpose of installings of the towbar one ought to disassemble the back bumper and take out the facing from the trunk.
- Make points in the back piece according to the fig. 2 and then drill holes $\varnothing 1$ mm.
- Apply the main bar of the towbar (pos. 1) to the back piece and fix through made holes and the washers (pos. 9) using bolts M110x30mm (pos. 8) from the accessories.
- Fix the longitudinal bar (pos. 4) to installed bar (pos. 1) through holes (pos. A) and fix using bolts M10x80mm (pos. 7).
- Through holes of the towbar (pos. B and C) drill holes $\varnothing 10$ mm. Then through plates (pos. 5) applied in the trunk fix using bolts M10x30mm (pos. 8) from accessories.
- Fix tow-ball (pos. 2) and socket plate (pos. 3) using bolts M12x85mm (pos. 6).
- Before installing the bumper one ought to cut out the rectangular fragment 120x80mm in the central point of lower part of the bumper.
- Install the back bumper to the car.
- Tighten all bolts according to the torque shown in the table.
- Connect electric wires of 7-poles socket according to the instruction of the car. (Recommend to make at authorized service station).
- Complete paint layer damaged during installation.

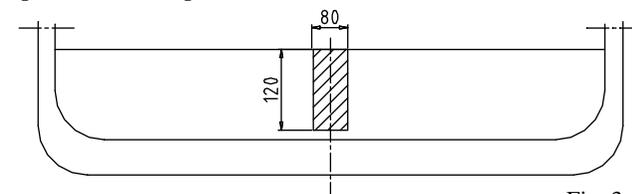
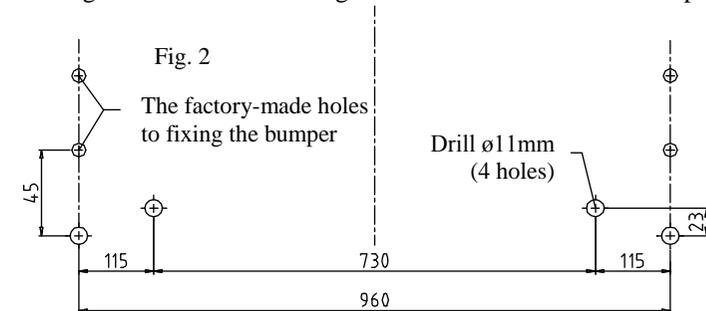

Fig. 3

Torque settings for nuts and bolts (8,8):		
M 6 - 11 Nm	M 8 - 25 Nm	M 10 - 50 Nm
M 12 - 87 Nm	M 14 - 138 Nm	M 16 - 210 Nm

NOTE

After install the towbar you should get adequate note in registration book (at authorised service station).The car should be equipped with:

- Indicators
- Tow mirrors

After 1000km of exploitation check all bolts and nuts. The ball of towbar must be always kept clear and conserve with a grease.

Towbar accessories:

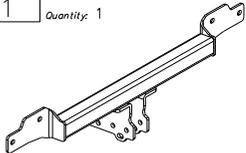
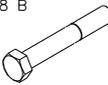
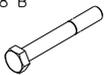
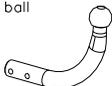
Pos. 1 Name: Main bar Quantity: 1	Pos. 6 Name: Bolt 8,8 B Quantity: 2 Dim.: M12x85mm	Pos. 12 Name: Plain washer Quantity: 2 Dim.: Ø 13 mm
	Pos. 7 Name: Bolt 8,8 B Quantity: 2 Dim.: M10x80mm	Pos. 13 Name: Plain washer Quantity: 10 Dim.: Ø 10,5 mm
		
Pos. 2 Name: Tow ball Quantity: 1	Pos. 8 Name: Bolt 8,8 B Quantity: 8 Dim.: M10x30mm	Pos. 14 Name: Spring washer Quantity: 2 Dim.: Ø 12,2 mm
		
Pos. 3 Name: Socket plate Quantity: 1	Pos. 9 Name: Washer Quantity: 4 Dim.: Ø35xØ12x3mm	Pos. 15 Name: Spring washer Quantity: 10 Dim.: Ø 10,2 mm
		
Pos. 4 Name: Longitudinal bar Quantity: 1	Pos. 10 Name: Nut 8 B Quantity: 2 Dim.: M12	Pos. 16 Name: Ball cover Quantity: 1
		
Pos. 5 Name: Plate Quantity: 2	Pos. 11 Name: Nut 8 B Quantity: 10 Dim.: M10	Pos. 17 Name: Cover plate Quantity: 2
		



PPUH AUTO-HAK S.J.

Produkcja Zaczepów Kulowych
Henryk & Zbigniew Nejman
76-200 SŁUPSK ul. Słoneczna 16K
tel/fax (059) 8-414-414; 8-414-413
E-mail: office@autohak.com.pl
www.autohak.com.pl

Towing hitch (without electrical set)

Class: **A50-X** Cat. no. **A16**

Designed for:

Manufacturer: **AUDI**

Model: **80**

Type: **4 doors, except Quattro, (B3)**

produced since 09.1986 till 08.1991

Technical data:

D-value: 8,23 kN

maximum trailer weight: **1500 kg**

maximum vertical cup load: **50 kg**

Approval number according to Directive 94/20/EC: e20*94/20*1393*00

Foreword

This towbar is designed according to rules of safety traffic regulations. The towing hitch is a safety component and can be install only by qualified personnel. Any alteration or conversion of the towing hitch is prohibited and would lead to cancellation of design certification. Remove insulating compound and underseal from vehicle (if present) in the area of the matting surfaces of the towing hitch. The vehicle manufacturer's specifications regarding trailer load and max. vertical cup load are decisive for driving whereat values for the towing hitch cannot be exceeded.

D-value formula:

$$\frac{\text{Max trailer weight [kg]} \times \text{Max vehicle weight [kg]}}{\text{Max trailer weight [kg]} + \text{Max vehicle weight [kg]}} \times \frac{9,81}{1000} = D \text{ [kN]}$$